

FRG GANCIO ROTANTE - ROTATING HOOK

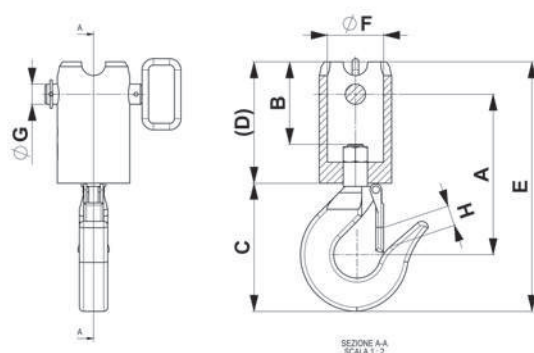

Modelli Models	A	B	C	D	E	F	G	H	Portata statica Static lifting capacity	Peso Weight
	mm	mm	mm	mm	mm	mm	mm	mm	kg	kg
FRG 35/50 - 5 T D25/41	222	85	168	150	318	50	25	41	3500	11.1
FRG 50/59 - 5 T D26/41	222	85	168	150	318	59,5	26	41	3500	10.5
FRG 50/59 - 5 T D30/41	222	85	168	150	318	59,5	30	41	3500	10.5
FRG 50/59 - 7,5 T D26/57	254	85	210	150	360	59,5	26	57	3500	12.1
FRG 50/59 - 7,5 T D30/57	254	85	210	150	360	59,5	30	57	3500	12.1
FRG 55/69 - 5 T D30/41	222	85	168	150	318	69,5	30	41	3500	12.1
FRG 55/69 - 7,5 T D30/57	254	85	210	150	360	69,5	30	57	3500	12.5

Adatto per tutti i tipi di rotatori - Suitable for all hydraulic rotators

In conformità/According 2006/42/CE EN12100:2010

FRG S GANCIO ROTANTE E BASCULANTE - ROTATING AND TILTING HOOK

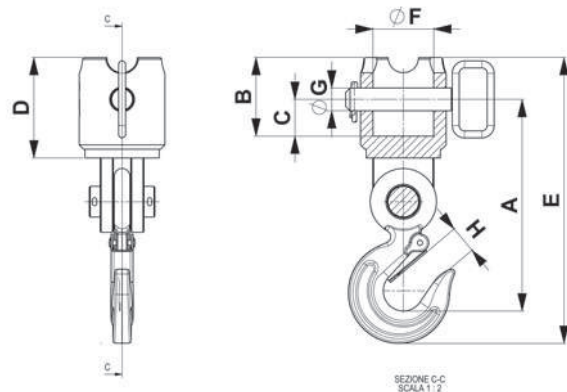







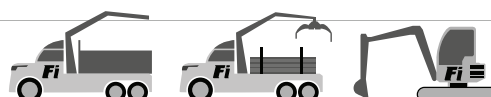

Modelli Models	A	B	C	D	E	F	G	H	Portata statica Static lifting capacity	Peso Weight
	mm	mm	mm	mm	mm	mm	mm	mm	kg	kg
FRG 50/59 S - 5 T D26	242	90	42	115	327	59,5	26	30	5000	8.7
FRG 50/59 S - 5 T D30	242	90	42	115	327	59,5	30	30	5000	8.6
FRG 55/69 S - 5 T D30	242	90	42	115	327	69,5	30	30	5000	8
FRG 85/69 S - 7,5 T D30	288	90	42	115	383	69,5	30	38	7500	14.2
FRG 128/78 S - 10 T D35	336	90	42	115	441	78,5	35	50	10000	19.4

Adatto per tutti i tipi di rotatori - Suitable for all hydraulic rotators

In conformità/According 2006/42/CE EN12100:2010



 GANCIO IDRAULICO
 HYDRAULIC HOOK
 CROCHET HYDRAULIQUE
 HYDRAULISCH LASTHAKEN

 GANCHO HIDRÁULICO
 ГИДРАВЛИЧЕСКИЙ КРЮК
 HİDROLİK KANÇALAR
 خطاف هيدروليكي

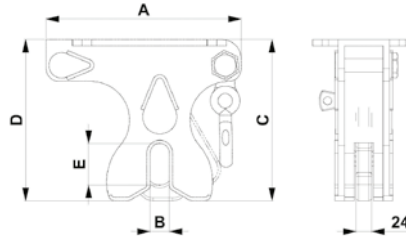
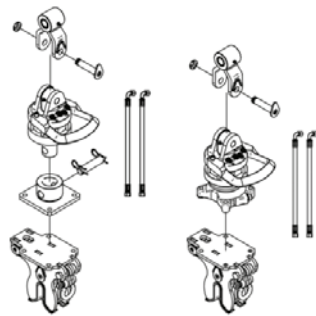









04



Modelli Models	A	B	C	D	Pressione Pressure	Peso Weight	Portata Lifting capacity	Rotatore consigliato Suggested rotator
	mm	mm	mm	mm	bar	kg	kg	
FGX 330	304	30	250	250	200	20	3300	FR 55 F

In conformità/According 2006/42/CE EN4413:2012 EN12100:2010

GANCIO PER CAMPANE VETRO 
 HOOKS FOR RECYCLING BANKS 
 CROCHET POUR CONTENEURS A VERRE 
 HYDRAULISCH GESTEUERTE LASTHAKEN FÜR GLASCONTAINER 

GANCHO CONTENEDORES RECICLAJE VIDRIO 
 КРЮК ДЛЯ БАКА ДЛЯ СБОРА СТЕКЛА 
 CAM ÇANLAR KANÇALAR 
 خطاف لحاويات الزجاج 

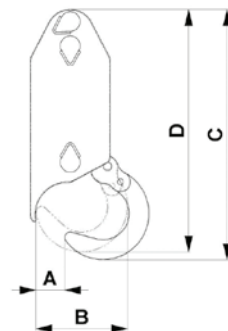
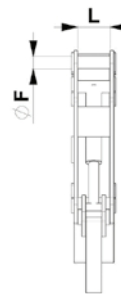

Gancio ad azionamento idraulico per
 la movimentazione delle campane di
 raccolta vetro e altri materiali
*Hydraulic hook for handling glass containers
 and other materials*

Su richiesta disponibile con predisposizione
 rotatore idraulico o rotatore idraulico montato
*On demand available with hydraulic
 rotator mounting predisposition or
 hydraulic rotator mounted*

Modelli Models	A	B	C	D	F x L	Pressione Pressure	Peso Weight	Portata Lifting capacity	Rotatore consigliato Suggested rotator
	mm	mm	mm	mm	mm	bar	kg	kg	
FGG 10	83	127	412	450	20x57	200	11	1000	FR 35
FGG 18	100	170	494	540	25x65	200	15	1800	FR 35
FGG 25	130	190	510	565	30x72	200	23	2500	FR 50

In conformità/According 2006/42/CE EN4413:2012 EN12100:2010

GNC 01-23



Ferrari
 International
 Hydraulic Equipment